

PROFINET – The Solution Platform for Process Automation

PROFINET will gain more importance in process automation due to both its actual capabilities, and its newly developed and planned properties. PI is working closely with well-known users of process automation to achieve this objective.

June 2015



Contents

1	Introduction	4
	1.1 Why PROFINET?	4
	1.2 From Ethernet to PROFINET	6
	1.3 Requirements of the process industry	8
2	Proven today: PROFIBUS PA	10
3	PROFINET in process automation: today and the near future	12
	3.1 Already implemented PROFINET functions	13
	3.1.1 Network installation	13
	3.1.2 Network management	14
	3.1.3 Network diagnostics	15
	3.1.4 Device diagnostics	16
	3.1.5 Device replacement	17
	3.1.6 Security	18
	3.1.7 Safety (SIL)	19
	3.2 Technologies and specifications undergoing implementation	20
	3.2.1 Configuration in Run	20
	3.2.2 Redundancy solutions	21
	3.2.3 Sequence of Events (SoE)	22
	3.2.4 Proxy technology	23
	3.3 Current work in progress: PA Profile 4.0	24
	3.4 The solution platform at a glance	25
	3.4.1 PROFIBUS PA on PROFINET via proxy	25
	3.4.2 PROFINET field devices	25
4	Outlook	26
5	Accompanying technologies and measures	27
	5.1 Uniform device integration through FDI	27
	5.2 Certified personnel assure the introduction of PROFINET in PA	28
6	Summary	29

1 Introduction

1.1 Why PROFINET?

The next generation in process automation

Industrial communication is one of the key technologies for modern automation. It is used to control and monitor machines and systems in manufacturing and production processes. Furthermore, it interconnects production islands and integrates adjacent tasks like logistics, quality assurance, and system maintenance to higher order business systems. In the future world of “Industrie 4.0”, the Industrial Internet of Things, and Big Data, industrial communication is of even greater importance. Easy-to-handle solutions with high performance capability for real-time, availability, flexible topologies, and integration – even over great distances – are needed to make use of the many possibilities of the digital world.

Ethernet technology and IP-based communication are the current driving force behind interconnectivity and thus all types of information flow on a global scale. Factory automation-related industries are benefiting from this through better products that can be produced in shorter time and at lower cost. This is exactly the reason – in the sense of ensured competitiveness – why Ethernet is undergoing further development for use in industrial environments.

As it relates to PROFIBUS & PROFINET International (PI), this concerns the currently ongoing step-wise replacement of PROFIBUS DP with PROFINET. This replacement is in full swing in factory automation with proven benefits for users (“*PROFIBUS DP is good, PROFINET has even more capabilities*”). Similar trends are evident in process automation. Process-related systems are typically complex in structure, consisting of different sub-systems with numerous devices and differing topologies, manufacturers and technologies. Plant Owners and Operators urgently want this complexity to be harmonized and the data and information systems to be fully integrated and easier to handle with resulting improvements in operational reliability. PROFINET fully meets these demands:

- PROFINET is 100% Ethernet and thus provides an ideal environment for interoperability at all levels of a plant. And PROFINET is precisely defined in its specifications, which is also a requirement for full interoperability.
- As a uniform technology in a plant, PROFINET also affects personnel costs. There is less training expense, fewer specialists are needed, and plant operation is more transparent and thus more reliable and cost-efficient.

- PROFINET is 100% Ethernet and is prepared for the close connection with IT resources. This is important when considering a generation break in IT operating personnel.
- Energy savings is a must! Like PROFIBUS, PROFINET has a wide selection of application-oriented “profiles” for solving certain tasks. A very topical example is PROFenergy, which enables energy saving during process-related standby periods of plant segments (robots, pumps, motors) and thus significant cost reductions.
- Replacing of field devices must be easy and reliable. PROFINET has a wide selection of intelligent mechanisms (e.g., automatic addressing and device replacement), which meet this demand in particular.
- Security is a must, particularly in the process industry with its sensitive processes. PROFINET already has a multi-level security concept and, because it is 100% Ethernet, it also shares in future security developments from the IT world.
- Operational reliability and availability are keywords for plant operators. PROFINET has already proven itself for many years “in the field” of the factory automation industries, and largely eliminates startup costs for new users in the process industry.

The answer therefore to the introductory question “Why PROFINET?” is as follows: As an Industrial Ethernet standard PROFINET offers plant operators and owners of process automation-related plants a large step forward in terms of standardization, integration, ease of use, security, and cost reduction! PROFIBUS & PROFINET International (PI) is working intensively on a comprehensive solution for process automation that includes existing and new PI technologies.

The goal is the development of **PROFINET as the solution platform for process automation**. A special working group was formed and carried out a study to compare the range of demands of the process industry on communication technology with the performance offered by PROFINET. Based on this research, a gap analysis identified the needed developments of the technologies and specifications. Special emphasis was put on the explicit specification of all functions needed to ensure interoperability between products of different manufacturers.

This white paper details which existing functions and capabilities of PROFINET already meet the demands of the process automation industry, and provides guidance as to specifications that are published, or under development, and could be implemented and utilized in future products.

1.2 From Ethernet to PROFINET

Applying technological progress

Ethernet originated in a joint project by DEC, Intel, and Xerox in the 1970s. It was conceived as a transmission medium with bus structure between multiple data stations in the local area with identical authorization. The data rate was 3 Mbps in the beginning. The IEEE Standard 802.3 emerged from this in 1982. Then, rapid development in the 1980s yielded Ethernet with over 10 Mbps all the way to Fast Ethernet with 100 Mbps. Today, a data rate of 10 Gbps has already been achieved. The term "Ethernet" describes both the hardware of the transmission medium (connectors, cables, distributors, etc.) as well as the data transmission (protocols, transmission forms, packet formats). Ethernet is an explicitly defined implementation of Layers 1 and 2 of the OSI Layer Model and is widely used with different protocols on higher layers (e.g., HTTP or SMTP, well-known from the internet).

Industrial Ethernet designates, among other things, further developments on various layers of the layer model with the objective of making Ethernet suitable for use in industrial automation. Special properties of Industrial Ethernet include:

- Robust, industrial-grade components and products
- Development of protocols which fulfill industrial requirements (e.g. real-time capability)

PROFINET is the open Industrial Ethernet-based standard developed and maintained by PROFIBUS & PROFINET International (PI). PROFINET is standardized in IEC 61158 and IEC 61784 and, as a universal communication technology, covers all requirements of automation technology. PROFINET is 100% Switched Ethernet according to IEEE 802.3 and is thus also open for application of all Ethernet technologies and parallel operation of multiple Ethernet protocols.

The functional scope of PROFINET can be scaled, according to multiple layered Conformance Classes (CC) each building on the previous, for adaptation to different use cases (Figure 1). These combine minimum application-oriented properties: CC-A includes the basic functions and is, for example, used in building automation. CC-B expands the functional scope to include network diagnostics and topology information; CC-B(PA) adds functions relevant for process automation such as redundancy and Configuration in Run (configuration changes during operation). CC-C further expands the functions for implementation of IRT (Isochronous Real Time) communication and is thus the basis for clock-synchronized applications. A detailed description of the CCs is contained in the PI document "PROFINET Conformance Classes" [7.041/042 d/e].

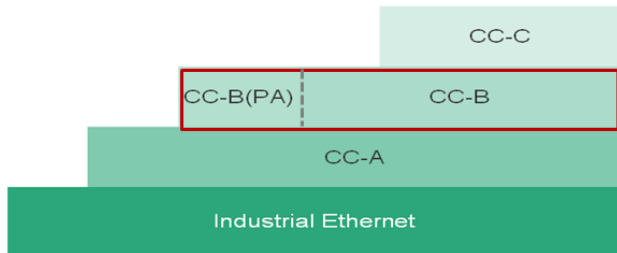

Figure 1: Structure of the Conformance Classes (CC) of PROFINET

The CCs with their defined contents are also the basis for **certification of the PROFINET devices** using a standardized test procedure in qualified test labs. Based on a positive test report, the device manufacturer receives a certificate which grants the right to brand the device with the PROFINET label. For plant builders and owners, the use of certified devices means time savings for commissioning and stable device behavior and, above all, interoperability during the entire period of use.

PROFINET recognizes the following **device families**: PROFINET Controller (corresponds to PROFIBUS Master Class 1), PROFINET Device (corresponds to PROFIBUS Slave), and PROFINET Supervisor (corresponds to PROFIBUS Master Class 2).

PROFINET is a platform with which the various sections of a plant or machine can be integrated into the automation landscape via an explicitly defined interface for communication and, in the future, for bus-powered devices in specific applications. This not only minimizes the number of different interfaces, but enables the exchange of information and knowledge (instead of data only) between the sections: For example, is a compressor, heat exchanger, or blower even capable of delivering the capacity needed for the setpoint? Or, what is the most economical operating point of a plant, given the status of the various units? PROFINET offers the comprehensive solution for this, with vertical and horizontal integration, by providing information instead of data, and with all the advantages of standard Ethernet.

1.3 Requirements of the process industry

Highest requirements must be met

Compared to factory automation, process automation places additional demands on communication technology. The plants, which usually extend over wide areas, have a lifespan of 15-40 years. These often consist of continuous production processes where interruption or disturbance can pose a serious hazard for people and the environment. An unplanned stoppage can also mean a large financial loss. Plant owners want to achieve an integrated data and information flow both horizontally and vertically. This yields clear specifications for the communication technology:

- Installation technology and field devices can be handled easily and by skilled staff
- Application in hazardous areas, including intrinsically safe ignition protection
- Long cable distances (up to 1,000 m)
- Flexible topology design
- Robust connection technology
- Redundancy concepts for critical components

The communication interface is to be standardized in order to ensure the smooth interaction of components of different manufacturers. The communication interface and the systems for engineering, asset management, and plant control should have the following properties:

- Maximum reliability and availability
- Disturbance-free configuration during plant operation
- Easy handling, especially for device replacement
- Investment protection for existing plants, including changes of the process control technology
- Suitable for large quantity structures of 10,000 or more devices

A particular expectation of the chemical industry was addressed in a keynote speech at the 2014 NAMUR¹ General Meeting: the merging of automation technology with the IT world, with the goal of protecting the competitive capability of chemical companies into the future. Together with the large plants in the chemical, petrochemical, and oil & gas industries, there are industry sectors with clearly lower requirements for, e.g., cable distances and explosion protection. These include the industries: food, environment, water and wastewater, life sciences, pharmaceuticals, etc.

PI defines the underlying technology for all listed requirements. The following sections provide an overview, starting from the current status of today's available technology and products, continuing with specifications already being implemented or about to be implemented and ending with planned further improvements. The further development of existing specifications and new definitions of technologies take aim at requirements that must be fulfilled in the future. The open and fact-based discussion in the PI committees leads to vendor-neutral, well-defined solutions for a heterogeneous process landscape.

¹ NAMUR is an international user association of automation technology in process industries, which is highly regarded especially in the European Chemical and Life Science industries.

2 Proven today: PROFIBUS PA

Digital to the device

PROFIBUS PA is the fieldbus that enables long cable distances and explosion protection for the harsh environments of process automation and offers complete digital integration of field instrumentation in control and asset management systems. The connection is made using a link/coupler typically via PROFIBUS DP (Figure 2). The user benefits of PROFIBUS PA result from, among other things, digital instead of analog communication with many positive consequences, a simple validation of intrinsically safe ignition protection (FISCO Model), and the properties of the PA 3.02 device profile tailored specifically to process industry needs.

The fieldbus combination “PROFIBUS DP with connected PA segment” is found in many installations worldwide, where it proves itself as both a high-performance and stable solution. Specifications and guidelines such as the proven PA 3.02 device profile provide the needed standardization, while the many field devices from various manufacturers provide users with a great deal of choice when selecting instrumentation for their plants.

To date, some requirements have not been tackled, especially in connection with *device replacement and device integration*. There used to be a need regarding excessive time expenditure and reliability of handling and an uneasiness about the existence of two very different integration technologies, which caused significant effort for users and manufacturers alike. Version 3.02 of the PA profile standardizes the compatibility of devices so that device replacement is possible independent of manufacturer and software version. The duplication of integration tools will soon end with the newly completed joint industry standard FDI (Field Device Integration), which also supports PROFIBUS PA.

PROFIBUS PA provides benefits in all stages of the life cycle of a process plant; from plant planning and construction as well as for installation, operation, and maintenance of the plant. PROFIBUS PA generates these benefits through automatic documentation and a shortened and effective loop check, reduced installation effort, easy proof of intrinsic safety for operation in hazardous areas, requirement-oriented maintenance, easy device replacement, etc.

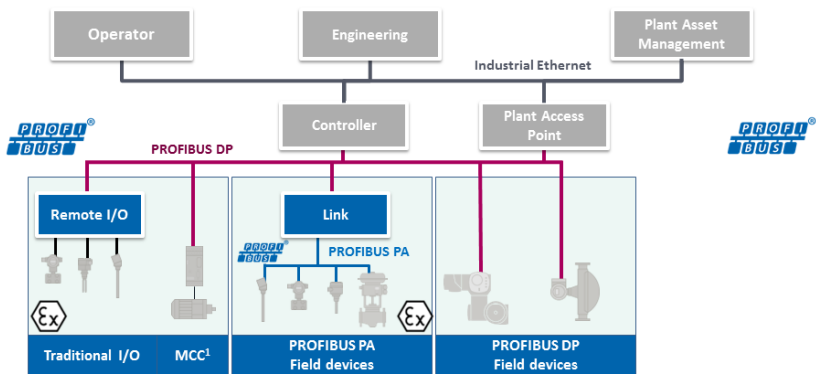

¹ MCC: Motor Control Center

Figure 2: Communication structure of a plant with PROFIBUS DP and PROFIBUS PA

PI sees PROFIBUS PA as an up-to-date key technology for the digitalization of field communication. Proxy specifications are well defined to implement the integration of current and future installations on PROFINET-based environments. This technology, optimally and transparently designed for engineering and operation, enables the migration strategies needed for the longevity of a process plant.

3 PROFINET in process automation: today and the near future

Planning and shaping the future today

Applications with PROFINET already exist today, especially in areas in which PROFIBUS DP was previously used and Remote I/Os or motor management systems were connected. However, this use case is subject to certain limitations because PROFINET functions such as “System Redundancy” and “Configuration in Run” are not yet implemented in all products.

Figure 3 shows, starting from the left, PROFINET devices such as Remote I/O and Motor Control Center (MCC), PROFIBUS PA field devices for explosion-proof applications, integrated in PROFINET using a proxy. A switch connects PROFINET field devices for applications without requirements for explosion protection, optionally supplied via Power over Ethernet (PoE).

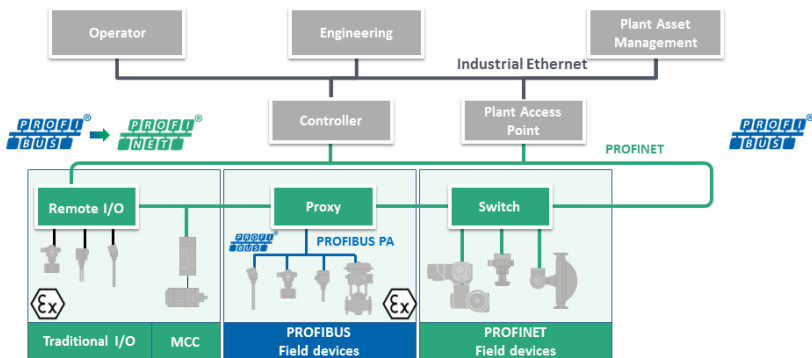

Figure 3: PROFINET & PROFIBUS PA

This chapter describes the pragmatic introduction of PROFINET in process technology. Section 3.1 describes already existing and implemented PROFINET functions. Section 3.2 provides an overview of already completed specifications that are currently being implemented in products. Regarding this, special emphasis is placed on the integration of existing bus systems using proxy technology. Section 3.3 covers topics which are currently being defined. Section 3.4 provides an outlook on the future. All standardization efforts pay special attention to investment protection.

3.1 Already implemented PROFINET functions

Proven PROFINET functions and technologies of importance to process automation and especially with field devices are: network configuration, connection technology, network diagnostics, topology display, detection of neighboring devices, device replacement and diagnostics. These functions enable automatic address configuration during device replacement, as well as the display of a plant, which can be used, for example, to ensure that a replacement device was connected at the correct port. The replacement device receives the same name and parameters as the replaced device. In addition, the topology display is used for diagnostic purposes and shows, for example, a wire break graphically at the corresponding location.

3.1.1 Network installation

Easy network installation and fully integrated network diagnostics

Maximum reliability and system availability is a basic requirement for use of communication technologies in process automation plants. This also applies to PROFINET and its connection technology.

The **network configuration of PROFINET** can be designed very flexibly, and optimally reflects the plant conditions. The following topologies are supported (Figure 4)

- Line topology, which primarily connects field devices with integrated switches in the field
- Star topology with a central switch located in the control cabinet
- Ring topology, primarily for implementation of media redundancy
- Tree topology, in which the topologies listed above are combined

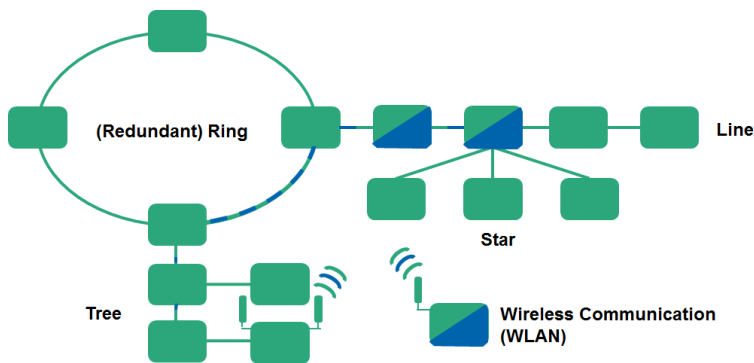

Figure 4: Flexible network configuration of PROFINET

Today's defined and utilized connection technology meets the requirements for wiring these switching techniques.

The **connection of PROFINET devices** is carried out exclusively using switches as network components, which are often already integrated in the device (2 ports). PROFINET-suitable switches must support both "Auto-Negotiation" and "Auto crossover" functions. As a result, communication can be established autonomously, and the physical cable designs are uniform. The nodes (devices and switches) are connected by copper cable up to a distance of 100 m. For longer transmission distances, fiber-optic cables are used.

3.1.2 Network management

In IT networks, the **SNMP (Simple Network Management Protocol)** has established itself as the de facto standard for maintenance and monitoring of network components and their functions. For diagnostic purposes, this protocol can read-access network components, in order to read out statistical data pertaining to the network as well as port-specific data and information for neighborhood detection. SNMP must be implemented for devices of Conformance Classes B and C.

3.1.3 Network diagnostics

PROFINET field devices use the **LLDP (Link Layer Discovery Protocol)** according to IEEE 802.1AB to exchange the available addressing information via each port. This allows the respective port neighbor to be explicitly identified and the physical structure of the network to be determined. In Figure 5, the “delta” device is connected to port003 of “switch1” via port001. With this **neighbor detection**, a preset/actual comparison of the topology is possible and changes of the topology during operation can be recognized immediately. This is also the basis for the automatic naming during device replacement.

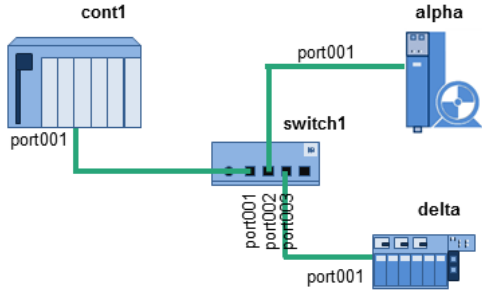

Figure 5: PROFINET field devices know their neighbors

The collection of the information obtained via neighborhood detection using the SNMP protocol enables a **graphical representation of the plant topology and port-specific diagnostics** (Figure 6).

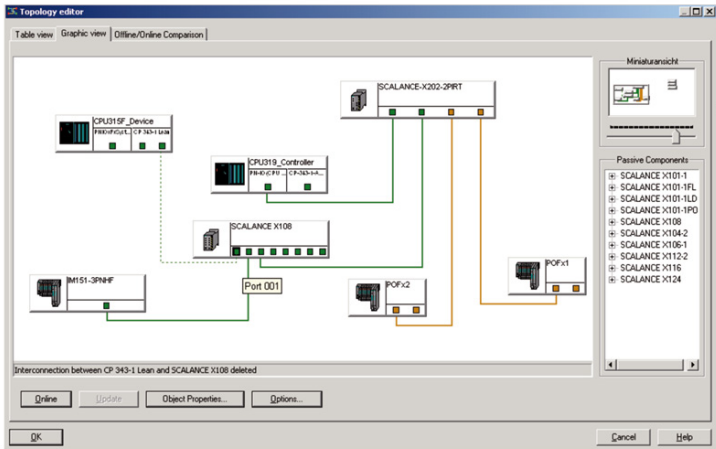

Figure 6: Representation of the plant topology

3.1.4 Device diagnostics

Uniform device diagnostics according to NAMUR NE 107

Status-oriented maintenance is important for operation and maintenance of plants. It is based on the capability of devices and components to determine their status and to communicate using standardized mechanisms. To this end PROFINET provides a system for reliable signaling of alarms and status messages from the devices to the controller. This diagnosis model (Figure 7) covers system-defined events such as removal/insertion of modules and the signaling of malfunctions such as a wire break that are detected by the control mechanisms. Besides the “good” and “faulty” status, the underlying status model also knows the optional levels “maintenance required” (e.g. when media redundancy is lost) and “maintenance demanded”. The module also distinguishes between diagnostic alarms (events within a device or component) and process alarms (events in the process, e.g. limit temperature exceeded). The document “Diagnosis for PROFINET” [7.142 e] contains further information.

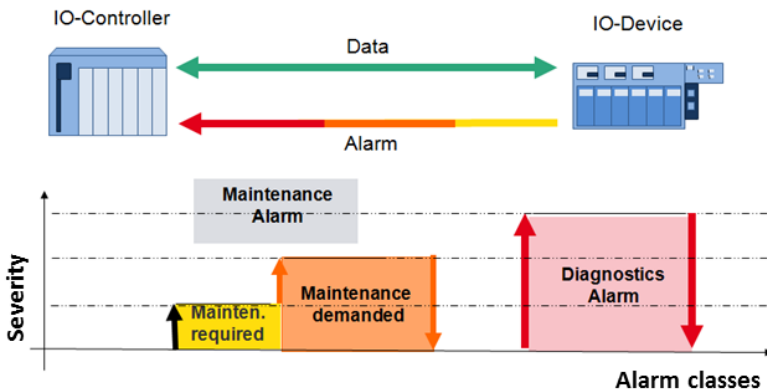

Figure 7: PROFINET diagnosis model for signaling faults with different priority

To ensure a uniform display of the different diagnostic messages, the results of the PROFINET diagnosis model have been assigned to the **diagnostic display according to the NAMUR NE 107** (Figure 8). This leads to a uniform display for all devices in a plant.

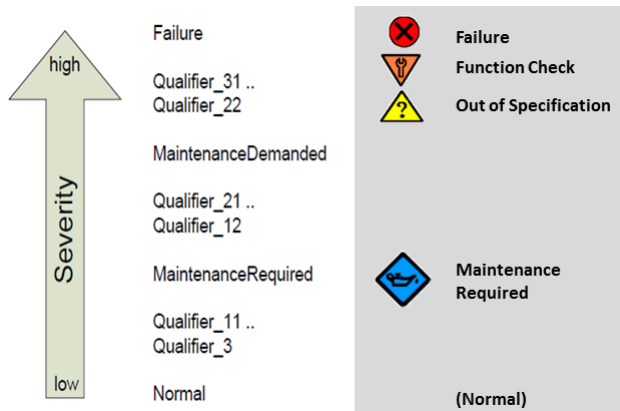

Figure 8: Assignment of the PROFINET device diagnostics to NAMUR NE 107 requirements

3.1.5 Device replacement

Simplified device replacement, easier than 4...20 mA

The replacement of PROFINET field devices can be performed easily and reliably. The basis for this is the cyclic exchange of neighborhood information of the devices. If a device fails, its neighborhood is known. A replacement device that is "nameless" to start is inserted, and the controller searches for the explicitly identifiable neighbor device of the defective device. As a result, the replacement device can be assigned the same position in the network, the same address, and the same parameter set as the failed device. In addition, the address and positioning of the device is also shown in the diagram of the plant topology and can be verified once installed. Altogether, this enables fast and reliable device replacement even without an engineering tool.

This continuous visualization of the network and the related ability to immediately detect, for example, address conflicts lend support to plant commissioning, modification and expansion. The result is significant time savings compared to past procedures.

Summary of user benefits (3.1.1 to 3.1.5)

- Automatic creation and checking of the topology (visualization)
- Accelerated commissioning and easy device replacement
- Easy configuring, even without an engineering tool
- Prevention of address conflicts
- Easier handling than 4...20 mA technology
- Continuity of diagnostic displays based on NAMUR NE 107

3.1.6 Security

For secure networking within a large factory or over the Internet, PROFINET provides a graduated security concept (Figure 9). This can be adapted to the application through configurable upstream security zones. As a result, this frees PROFINET devices from being overloaded with security mechanisms. Furthermore, the concept can be optimally adapted to the changing security requirements over the plant's lifetime and

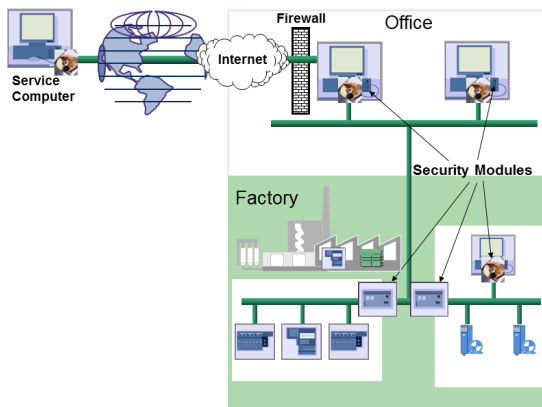

Figure 9: Access to machines and systems using secure connections

to technical innovations. Individual devices and whole networks can be protected from unauthorized access. This is accomplished by security modules that allow networks to be segmented and, thus, also separated and protected. Only explicitly identified messages reach the devices located inside such segments from the outside (Figure 10). For more information, see the PI document "PROFINET Security Guideline" [7.001/002 d/e].

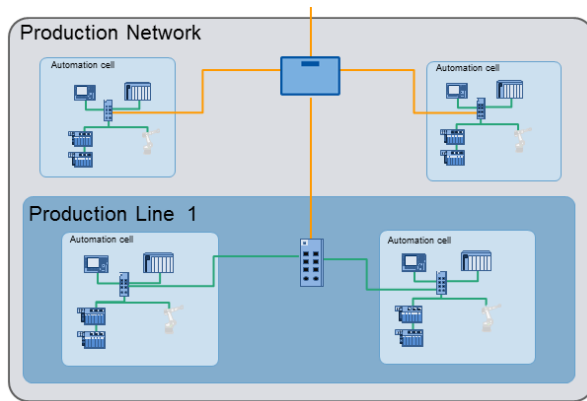

Figure 10: Segmentation of the network

3.1.7 Safety (SIL)

Two solutions for optimum safety

A consistent communication path must be possible for safety-relevant applications. One possibility for this already exists today in the form of Safety with 4...20mA/ HART using Remote I/O or Proxy. A future solution is based on PROFIsafe. PROFIsafe is the protocol defined in IEC 61784-3-3 for implementing functional safety (fail-safe). PROFIsafe is recognized by IFA and TÜV, and can be used with PROFIBUS and PROFINET alike. As a result, elements of a fail-safe controller can be transferred directly with the process control data on the same network. Additional wiring is not needed. An introduction to PROFIsafe can be found in the system description [4.341]. The specification is available at [3.192].

3.2 Technologies and specifications undergoing implementation

Important and already released specifications for using PROFINET in process automation are: *Configuration in Run* for disturbance-free changes during operation, *Media and system redundancy* for very high system availability, *Proxy technology* for investment protection through transparent integration of existing systems such as PROFIBUS PA and other communication technologies in PROFINET as well as exact *Time stamping*. It is only a matter of implementation by the device manufacturers until a scenario shown in Figure 2 in the form of a combination of PROFINET and PROFIBUS PA becomes reality. The interoperability between devices and components of various manufacturers, which is extremely important for practical use, can only be achieved if manufacturers comply exactly with the explicitly defined specifications during implementation.

3.2.1 Configuration in Run

Continuous operation without interruption: 24/7

Configuration in Run (Changes during operation) refers to the feature based on redundant communication connections that enables problem-free interventions in the plant without affecting the communication in the network. This applies to actions taken on or with compact devices as well as to modular devices and proxies (Figure 11, starting from left).

Examples: change of device configuration, device replacement, addition or repair of components, change of parameters, etc. See also the PI document "PROFINET Configure in Run" [7.112 e].

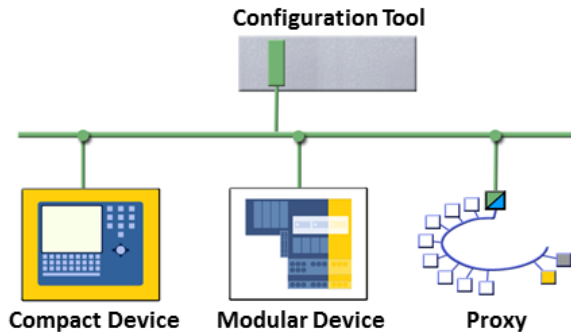

Figure 11: Universal use of Configuration in Run

3.2.2 Redundancy solutions

Two concepts for high availability

High system availability is ensured through high-performance PROFINET redundancy solutions. Developed by PI, they include media and system redundancy, and have been standardized to ensure interoperable behavior of devices of different manufacturers.

In the case of media redundancy the PROFINET device has more than one physical connection path to the controller (Figure 12). When one communication path fails (for example, due to a cable break), the second communication path is automatically used, thus the communication with the connected PROFINET devices continues. For more information, see the PI document “PROFINET Media Redundancy in PA systems” [7.092 e]

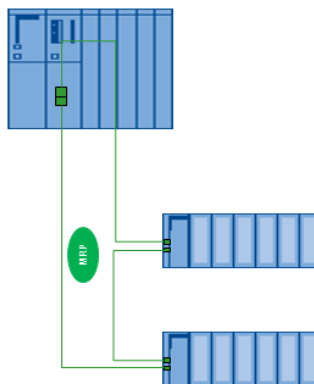

Figure 12: Media redundancy

Summary of user benefits:

- Electrical ring topology possible
- No additional hardware needed
- Combination with system redundancy possible

In the case of system redundancy a PROFINET device establishes more than one communication relation with a redundant controller. A distinction is made here between different ways of implementing system redundancy. S2 system redundancy (Figure 13, left) describes a compact PROFINET device, such as a field device, that can be operated on a system with high availability with no need of additional hardware. R1 and R2 system redundancy (Figure 13, center and right) refers to the redundant realization of the communication interface of a modular PROFINET device for example, with a Remote I/O. R2 system redundancy achieves maximum plant availability through its 4 paths between the controller and device. Support of system redundancy is mandatory for PROFINET devices of process automation in CC-B(PA). For more information, see the PI document “PROFINET System Redundancy” [7.122 e]

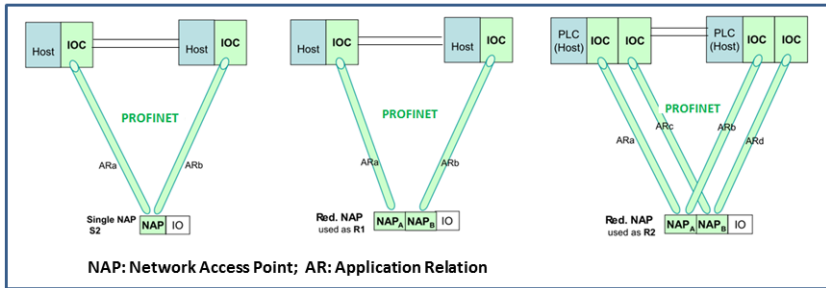

Figure 13: System redundancy

Summary of user benefits:

- Availability is scalable by the user
- Various methods of system redundancy can be implemented
- Maximum availability through 4-path redundancy (R2 system redundancy)

3.2.3 Sequence of Events (SoE)

Precise cause analysis based on time stamping

In large plants, the ability to record the actions, alarms and status messages to a sequence of events is often required. With its high-accuracy time stamping, PROFINET provides a standardized (IEEE 1588) solution including archiving and control. For more information, see the PI document “PROFINET Clock Synchronization” [7.102 e].

3.2.4 Proxy technology

Migration strategies for the installed base

With proxy technology, existing plant sections can be integrated into a PROFINET infrastructure (Figure 14). For process automation, this incorporates the existing fieldbus systems PROFIBUS DP/PROFIBUS PA, FOUNDATION Fieldbus H1, HART and others.

Proxies are gateways that represent devices in a structured manner in the PROFINET network. The control systems can use them to access the field devices cyclically as well as acyclically. Properties of the fieldbus systems, such as the diagnostics and configuration, can be used as native properties in the PROFINET world.

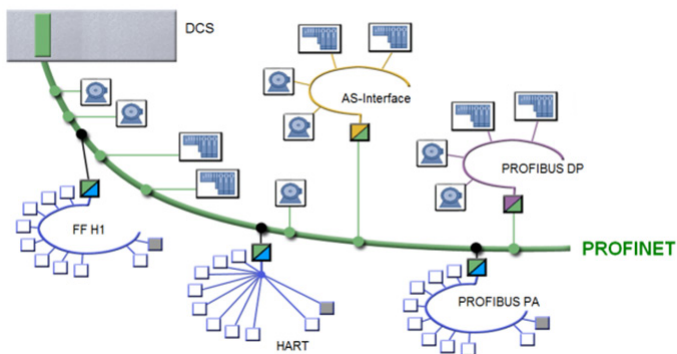

Figure 14: Investment protection through integration of plant units using proxies

Summary of user benefits:

- Openness through integration of existing fieldbuses and installed base
- 100% investment protection for device manufacturers and end users
- Allows stepwise upgrade of PROFIBUS systems to PROFINET systems
- Standardized engineering
- Suitable for applications in hazardous areas

3.3 Current work in progress: PA Profile 4.0

Using the PA Profile with PROFINET

The “PA Profile” (current version PA 3.02) is the generic device profile of PI for process field devices. It ensures uniform behavior of PA devices of various types and from different manufacturers during engineering and operation with PROFIBUS PA.

Requirements and expertise of manufacturers and users (including consideration of “core parameters” for easy device commissioning and replacement) are currently being incorporated into a revised profile version. This will contain all useful elements of Version 3.02 and will additionally be independent of physical layer and protocol. The result will be a PA 4.0 device profile that can be used uniformly with PROFIBUS and PROFINET systems.

Examples of the resulting user benefits include:

- Significantly easier and uniform processes for engineering, installation, commissioning, and replacement of devices. For example, profile devices will be commissioned according to a uniform procedure.
- For vendor-neutral configuration of field devices in the control system, devices with the PA profile offer a standard interface in the form of the “neutral channel”, which represents the combined functions of the devices and provides these in an expanded GSD file for device integration.
- The proven NAMUR NE 107-based diagnosis model is retained and is being revised and adapted in dialog with all industry participants.
- The transmission of large data quantities made possible by Industrial Ethernet expands the former data exchange into an information exchange. As a result, not only data and keywords but also meaningful information from the entire plant is made available to the operator.
- The unit of the measured value is synchronized between the field device and the control system.

3.4 The solution platform at a glance

In the short-term and medium-term, PI sees two technologies as keys for process automation: PROFIBUS PA for plants with long cable distances and hazardous areas and PROFINET devices with currently available interfaces in compact plants and selected industry sectors.

3.4.1 PROFIBUS PA on PROFINET via proxy

Consistent investment protection through proxies

As already presented in Section 2, PROFIBUS PA is today's established, up-to-date, and future-proof solution for process automation. Digital to the last mile, suitable for use in hazardous areas, bus-powered, with the PA Profile 3.02 reflecting the needs of process automation, implementation of NAMUR NE 107 – and most recently – the state-of-the-art support of FDI for PROFIBUS PA. Through the use of proxies (Figure 14 and 15), it becomes possible to combine the strengths of two technologies already industry proven for years and ensure investment protection for other established technologies over the long term.

3.4.2 PROFINET field devices

With PROFINET down to the field level

Some industry sectors, such as food, environment, and life sciences, have hybrid installations in which technologies of factory and process automation are used in parallel. Often there are no demands for explosion protection or very long cable lengths so that the interface and installation technology established in the factory automation can be used. For the process devices used in these applications, PROFINET will be able to gradually replace the usual PROFIBUS DP (Figure 14) with the optional use of PoE (Power over Ethernet). This solution enables users to have a consistent information flow, a seamless integration into automation systems, and open access for device configuration and diagnostics via Ethernet.

4 Outlook

To meet the demands of vertical and horizontal integration, the community seeks to define a common and seamless communication down to the field level. Developments towards a uniform physical layer for Ethernet-based communication are taking place independent of PI will, and meet the requirements named in Section 1.3:

- Power and communication via one medium
- Long cable distances up to 1,000 m
- Easy-to-handle installation technology
- Ignition protection for hazardous areas
- PROFINET support for the new physical layer.

Figure 15 shows, starting from the left PROFINET devices such as Remote I/O and Motor Control Center (MCC), PROFIBUS PA field devices for applications in hazardous areas, integrated in PROFINET using a proxy, and PROFINET field devices connected to a switch for applications without requirements for explosion protection, optionally with Power over Ethernet (PoE), and a possible integration via a new physical layer.

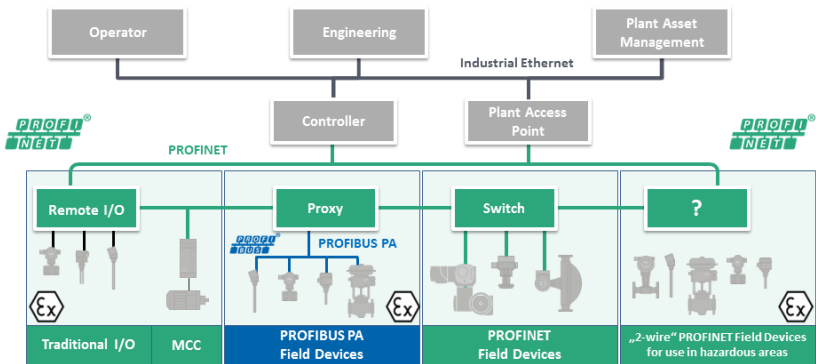

Figure 15: Communication structure with PROFINET field devices and PROFIBUS PA investment protection

5 Accompanying technologies and measures

5.1 Uniform device integration through FDI

The duplication ends

By default, PROFINET uses XML-based device descriptions (GSDML) for plant engineering. The properties and functions of the PROFINET devices are defined in these descriptions. As was previously the case with PROFIBUS technology, this information is not sufficient for the tasks in the process industry, which led to the development of two alternative integration technologies in fieldbus technology: EDDL and FDT/DTM.

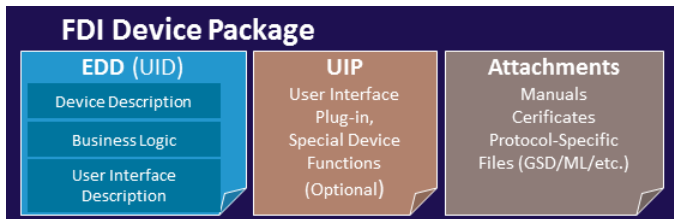

Figure 16: The FDI technology building blocks

A situation of this type is to be avoided for PROFINET through the new FDI technology according to IEC 61804, for which the first tool was introduced at the 2015 Hanover Fair. The FDI technology combines the strengths of the two previous technologies, adds the harmonization of the EDDL dialects and is optimized for uniformity of the host representations. There is exactly one device package for each field device (device package, Figure 16). This is a binary coded file containing a description of the data and functions of the device based on the latest harmonized EDD description language together with the description of the user interface (UI) and optional appendices. "Common FDI host components" ensure that device integration packages are processed the same in various FDI hosts. A cross-protocol development environment is available for developing FDI device packages for PROFIBUS, PROFINET, FOUNDATION Fieldbus H1, and HART devices.

5.2 Certified personnel assure the introduction of PROFINET in PA

Worldwide uniform training by PI

Devices, systems, and plants can only deliver their full performance with professionally trained staff. This requires thorough education and periodic training for developers and planners, and operating and maintenance personnel. PI has offered this for decades in the form of training courses and technology workshops for engineers and technicians. Participants receive a certificate on successful completion. The course providers, namely PI Competence and Training Centers, are periodically audited. This ensures high quality and uniform training standard worldwide.

This offer, which the market makes intensive use of, is based on the PI network spanning the globe with 27 Regional Organizations, 28 Training Centers, and 51 Competence Centers in 2015, which enables the local training of users “close to home”. The network bundles the comprehensive expertise of almost 1,500 member companies and the practical experience in automation technology accumulated over 25 years and makes both available to attendees in the training courses.

Certified personnel for PROFINET in the PA

The global PI training infrastructure is used for all technologies developed and supported by PI and increasingly for PROFINET in process automation. Specific plans exist to expand the long-standing program of PROFINET courses with topics for use in process technology. Likewise, the proven training program for PROFIBUS DP and PROFIBUS PA will be expanded to include add-on blocks from the PROFINET world. As a result, courses will be offered for new users in addition to advanced courses for already certified engineers and technicians. The goal of this “qualified personnel concept” is to enable users of PROFINET in process automation to make use of the new technology and its technical and economic benefits as quickly as possible.

6 Summary

Purposefully developed, proven, future-proof, and easier than 4...20 mA

PROFINET is the logical technological advancement of the successful PROFIBUS fieldbus into today's leading communication technology based on Industrial Ethernet. This enables a cost-effective migration to PROFINET due to the direct reuse of knowledge and the option for an incremental approach. Reasons for this migration are as follows:

- PROFINET is a global industry standard and is 100% standard Ethernet, which enables use of all web technologies.
- PROFINET has proven itself for years in factory automation and in machine building, thereby ensuring a high level of operational reliability.
- PROFINET has placed a very high value on user expectations regarding ease of use and has significantly surpassed the highly-praised conventional 4...20 mA standard.
- Through the use of proxy technology, PROFINET allows reuse of existing plant systems and thus provides excellent investment protection.
- Based on its network and diagnostics management, PROFINET provides optimal solutions for key issues of the process industry such as easy device handling and detailed diagnostics from devices and the network.
- PROFINET is Switched Ethernet and thus satisfies the demand of process industries for flexible plant topologies spread over a wide area.
- Through high-performance redundancy solutions, PROFINET ensures a very high availability of the plant. The availability can be scaled to suit the requirements of the user.
- PROFINET implements seamless horizontal and vertical integration for data and information.
- PROFINET enables transmission of large data quantities in real-time, thus paving the way for future tasks in connection with the Internet of Things.
- PROFINET and its associated functions are explicitly specified, which ensures the interoperability of devices of different manufacturers.

PROFINET as a solution platform for process automation timely provides all technology and tools required by process industries to fulfill the need for integrated automation of plants based on Industrial Ethernet. The major first step is the application PROFINET in new process automation plants and new plant sections with tools for integration of the installed base of 4...20 mA, PROFIBUS PA, and other bus systems. Technologies for a horizontally and vertically integrated PROFINET automation solution for process technology will be developed in the near future. Both steps will contribute to improving the efficiency of companies and thus their competitive position in the environment of "Industrie 4.0" and the Industrial Internet of Things.

Space for Notes

Published by:
PROFIBUS Nutzerorganisation e. V. (PNO)
Working Group Marketing in Process Automation
Member of PROFIBUS & PROFINET International
Haid-und-Neu-Str. 7 • D - 76131 Karlsruhe
Fon +49 721 96 58 590 • Fax +49 721 96 58 589
www.profibus.com • www.profinet.com